



Protective Solutions

for Sustainability!

We produce environmentally friendly protective solutions for a sustainable world.



www.cagplastik.com.tr
info@cagplastik.com.tr
+90 232 853 97 00



Çağ PLASTİK®

It offers a wide range of products such as high-quality Greenhouse Films, Mulch Films, Industrial PE-Film Rolls, Solarization Films, Silage Films, Pallet Covers, Stretch Film, Shrink Film, PE Stretch Hood and Polyethylene Bags in its modern facilities in Izmir. Çağ Plastik is an integrated manufacturer with PE-Film production, recycling units and Masterbatch production units in its facilities.

www.cagplastik.com.tr info@cagplastik.com.tr +90 232 853 97 00

Contents

Çağ Plastik

About Us.....	5
Vision and Mission.....	6
Company Values.....	7
COEX Technology.....	9
Our Certificates and Quality Documents.....	10

Industrial Films..... 12

Pallet Covers.....	14
Shrink.....	15
Stretch Hood Films.....	16
Bags (Printed & Unprinted).....	17
Polyethylene Packaging Films (Original and Recycled Films).....	18

Agricultural Films..... 20

Mulch Films.....	24
PE Silage Cover Films.....	25
Solarization Cover Films.....	26
PE Heat Curtains.....	27
Greenhouse Films.....	28

Informational Supplements

Product Ranges.....	30
Technical Details of Product Ranges.....	31
Folding Types.....	32
Jumbo Rolled Films.....	33
Additives of Greenhouse Films.....	34
Instruction Manual.....	36
Covering The Greenhouse Films - (Uncovering The Rolls).....	37
New Generation Anti-Fog Additive.....	38



About Us

Çağ Plastik started its operations in 1979 in the Bayındır district of İzmir with the retail sale of agricultural and industrial products. It has a deep-rooted history in its sector and continues to grow as a leading manufacturer. The company proved itself in the wholesale sector under the name İzbay Ticaret between 1983-1993 and made a name for itself with the experience it gained in İzmir Kemeraltı Outdoor Bazaar and Yenişehir Trading Center. In 1993, it was restructured under the name Çağ Plastik and expanded its wholesale and marketing activities even further. Çağ Plastik, which stepped into industrialism with its first production facility established in Karabağlar in 1995, strengthened its presence in the sector by increasing its production capacity with the opening of its factory in Torbalı Yazıbaşı in 1997.

Since 2016, it has continued its production and marketing activities in its modern facilities in Pancar Industrial Zone. Çağ Plastik offers a wide range of products such as greenhouse films, mulch films, industrial PE film rolls, solarization films, silage films, pallet covers, stretch film, shrink film and PE-Bag in its modern facilities in Izmir. Çağ Plastik is an integrated manufacturer with PE film production, recycling and masterbatch production in its facilities. With over 30 years of production experience and expert staff, the company offers innovative solutions to its domestic and foreign customers and has documented its quality with the ISO 9001:2015 certificate. Exporting 30% of its production, Çağ Plastik has a high prestige in the Turkish market with its quality difference.

It draws attention with its environmentally friendly production approach and contributes to a sustainable future by recycling waste back into the economy through recycling facilities. The company, which continues its leadership in the sector with its annual production capacity of 12.000 tons and wide product range, serves as a reliable solution partner to companies operating in the fields of agriculture and industry.

The company founder Şener Gençer is actively involved in Non-Governmental Organizations (NGOs). Gençer, who has held positions such as the Aegean Region Chamber of Industry Professional Committee and Assembly membership, became a member of the Board of Directors of the Aegean Plastic Industrialists Association (EGE-PLASDER) in 2002, and as of 2020, he continues to increase his effectiveness in the sector by assuming the roles of Vice President of the Turkish Plastic Industrialists Federation (PLASFED) and President of the Board of Directors of the Aegean Plastic Industrialists Solidarity Association (EGE-PLASDER).

Vision

To Produce protective solutions for sustainability.

Mission

To rise to a leading position in the sector by offering plastic film solutions with our customer-oriented approach. Increasing efficiency by continuously improving quality and performance, and offering innovative and sustainable solutions with R&D and innovative technology investments are our main goals.





Company Values

Experience and Expertise

We make a difference in the sector with our experienced infrastructure and manpower.

Quality Focus

We ensure customer satisfaction by prioritizing quality in our products.

Employee Satisfaction

We ensure that our employees are in a happy, long-lasting, and safe working environment.

Respect and Participation

We respect our employees, value their ideas, and create a participatory environment.

Sustainable Growth

While aiming for balanced and profitable growth, we remain a reliable institution that values people.

Innovation with COEX Technology



COEX-3 Technology

We bring together innovative technology and superior quality standards for agriculture and industry in plastic film production. With our COEX (coextrusion) production technology, films are produced in three separate layers.

In this way, different features are added to each layer, providing high resistance to external environmental conditions, while specific features are added for the inner surface of the film. COEX technology increases efficiency in agricultural production and provides the opportunity to offer special solutions for various production needs in the industrial field.

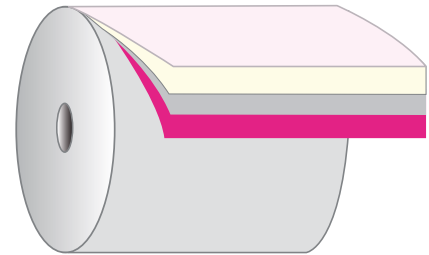

Our R&D and P&D Laboratory: The Heart of Innovation

Our laboratory in the factory, where R&D and P&D units are located, has advanced technical testing capabilities for quality control and inspection processes. In our laboratory, high precision tests are carried out using the most modern devices and equipment.

- Tensile Tester
- UV-VIS Spectrophotometer
- FTIR Analysis Devices
- Dart Impact Tester
- Digital Micrometer
- High Precision Scales
- Etüv Oven (Sterilizer)
- Light Table
- Moisture Analyzer
- TOX-100 Sulphur and Total Halogen Analyzer
- Anti-Static and ESD Test equipment

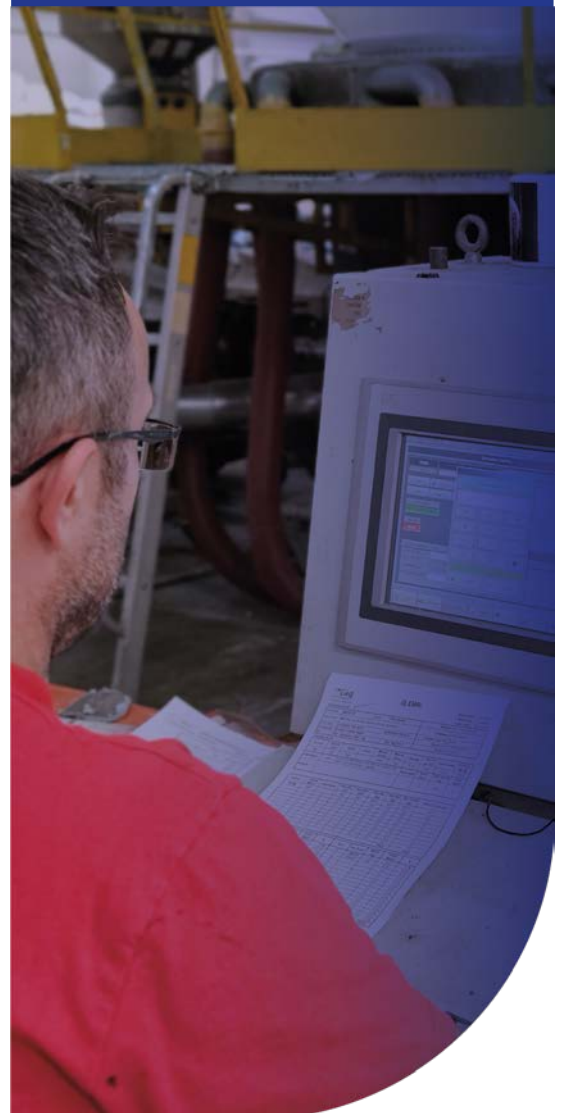

Assurance of Trust and Exclusive

Our company conducts its activities by adhering to international quality standards and environmentally friendly production principles. By prioritizing quality and sustainability at every stage of our production processes, we offer our customers products at the highest standards.

The certificates and memberships we have in many areas, from quality management to environmental safety, from technical qualifications to sustainability reports, reflect our sensitivity and awareness of responsibility in this regard.

Our certificates document the excellence of our quality management systems, our sensitivity to the environment and product safety. Additionally, we collaborate with leading organizations in the field of biodegradable products and sustainability. These certificates held by our company strengthen our understanding of high quality and commitment to sustainable production.

Quality & Certificates

- ISO 9001:2015 Quality Management System Certificate
- Environment" (ISO 14001) and "Technical Safety" (ISO 45001) certificates.
- Ministry of Agriculture, "Certificate of Registration Materials Found in contact with food"
- TSE "Turkish Standards Conformity Certificate"
- WELLS REVERTE Bio-degradable Approved Processor Certificate
- INTERTEK Migration Reports
- SGS inspection Reports & Bureau Veritas COC Certificate
- SEDEX Membership
- ARIBA Membership
- ECOVADIS Sustainability Reports



Quality & Certificates

Industrial Films

Industrial Films

The Main Industrial Products of Çağ Plastik Factory Manufacture:



Our range of industrial plastic films is manufactured to meet all kinds of needs in flexible packaging. Plastic films are lightweight, transparent, unaffected by biological agents, resistant to chemicals and atmospheric conditions, printable, corrosion resistant, unbreakable and unaffected by temperature changes between 60 - 200 °C.

Plastic films are a thin and elastic layer of an organic substance in packaging language. It is the most sought-after and respected packaging material due to its very low permeability, transparency and smooth surface.

Polyethylene is the simplest plastic in terms of structure and is made by adding ethylene gas in a high temperature and pressure reactor. Depending on the polymerization conditions (temperature, pressure and catalyst), a range

of low, medium and high-density resins are produced. Processing conditions control the degree of branching in the polymer chain and therefore the density and other properties of the films and other types of packaging. Polyethylene can be easily heat sealed.

As Çağ Plastik Factory, we use in production and especially in the industry while producing the main packaging material films; We process the main raw material types of polyethylene (PE, LDPE, LLDPE) as a manufacturer. We are an innovative manufacturer of high-quality Industrial Packaging Films used in almost all industries and areas.

Pallet Covers

Pallet covers are manufactured in a wide range of types, thicknesses, dimensions and colors. The pallet covers are used to protect the products from humidity, dust and dirt in transit. The pallet covers are preferable to stretch covers: superior protection against rain and humidity, higher mechanical strength and UV resistance. These covers are simple and easy to use. The covers can be provided in perforated rolls or as individual units.

Pallet Cover Types

- Transparent and tinted (as per customer requirements).
- UV-stabilized (protection) for outdoor use.
- Covers with antistatic (AS-Additives) properties.
- High-COF (coefficient of friction) covers.

Applications:

- Chemical industry
- Construction industry
- Hygiene and paper product packaging
- Tile packaging (Ceramic Sector, etc.)
- Plastic raw material pallet packaging (Petrochemical Companies, etc.)

Shrink Pallet Cover (Shrink Hood)

They are gusseted PE bags used in packaging palletized materials. Different additives can be used according to customer demand and intended use to give the film a different feature for each application (Table-1)

Dimensions are determined according to the size of the pallet to be packaged and simple sizing can be done as given below. Film thickness is generally between 80-200 microns.

After heat treatment (in automatic machines or manually), they shrink in width and length and tightly wrap the packaged material. Shrinkage rates in both directions are controlled and these rates are provided with appropriate raw material selection and process conditions.

Pallet cover is used to prevent the product on the pallet from being contaminated by external factors such as wind, rain, dust and the dispersion of the product.

Generally, their areas of use are ceramics, chemicals, paper, furniture, white goods, etc. sectors.

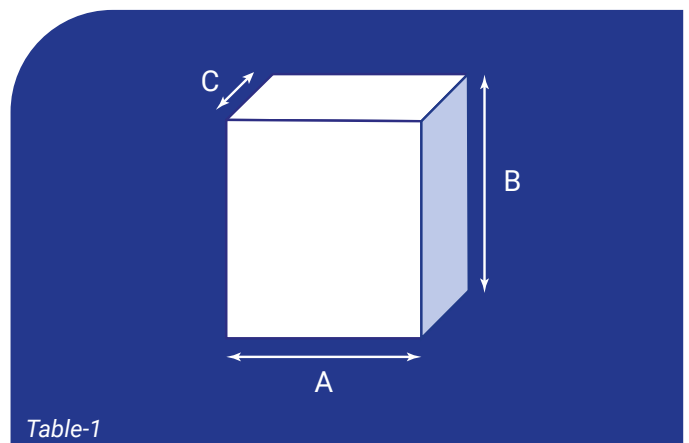

Table-1

Shrink

Shrink films, which are widely used in the packaging and wrapping field, have transverse and longitudinal shrinkage properties after being subjected to heat treatment. Shrinkage rates in both directions are controlled and these rates are provided with appropriate raw material selection and process conditions. Film thickness, inflation rate, thinning rate, raw material(s) used, and temperature and time during shrinking are the basic factors that determine shrink properties.

Shrink Film

Shrink films, which are used in a wide range of widths and thicknesses, are most commonly used in width / thickness ranges of 40 - 100cm / 40 - 90 microns.

The benefits of shrink films, which are generally preferred in the packaging of cardboard boxes, beverages, canned goods, paper packages, etc.:

- It wraps in accordance with the shape of the product.
- It gives shine to the product it wraps.
- It extends the shelf life and protects the product.
- It enables the transportation of products in bulk.
- Packaging costs are cheap.

Different additives can be used to give the film a different feature for each application, depending on customer demand and intended use.

Advantages of Shrink Film Packaging:

- Reduces packaging volume,
- increases stacking capacity.
- Environmentally friendly due to reduced packaging volume.
- Unlike cardboard packaging that requires adhesives, single component packaging.
- Double packaging performance.
- Resistant to high and low temperatures and UV resistance.
- Resistance to liquids and moisture.
- Good mechanical properties.



Stretch Hood Films

These films feature exceptionally high mechanical strength and elasticity compared with regular polyethylene films. These properties enable the films to be stretched lengthwise and crosswise without damaging the films themselves. These films are used as packaging for pallets containing polymers, chemicals, various raw materials, construction and infrastructure products.

As shown in the figure below, the film gets stretched in both directions and, when released from the dispensing machine, it reverts to its initial dimensions and clings to

the packed product without needing heating as is the case with the shrink films.

The stretch hood films can be ordered in various shades, thicknesses, widths and lengths. They can also be delivered pre-printed in accordance with customer requirements.

Advantages of Stretch Hood Films:

- Energy-efficient – no need for heating to shrink the film.
- Time-saving – eliminates the time required for shrinking the film.
- Safety: operators are not exposed to heat or to the heating by products.
- As seen in the graphic below, Pallets are packaged with Stretch Hood application machine.
- Stretch Hood is a flexible Polyethylene Film.
- Packaging and application are easily done to pallets with the application machine.
- They are durable Polyethylene Films with high mechanical properties and strength.

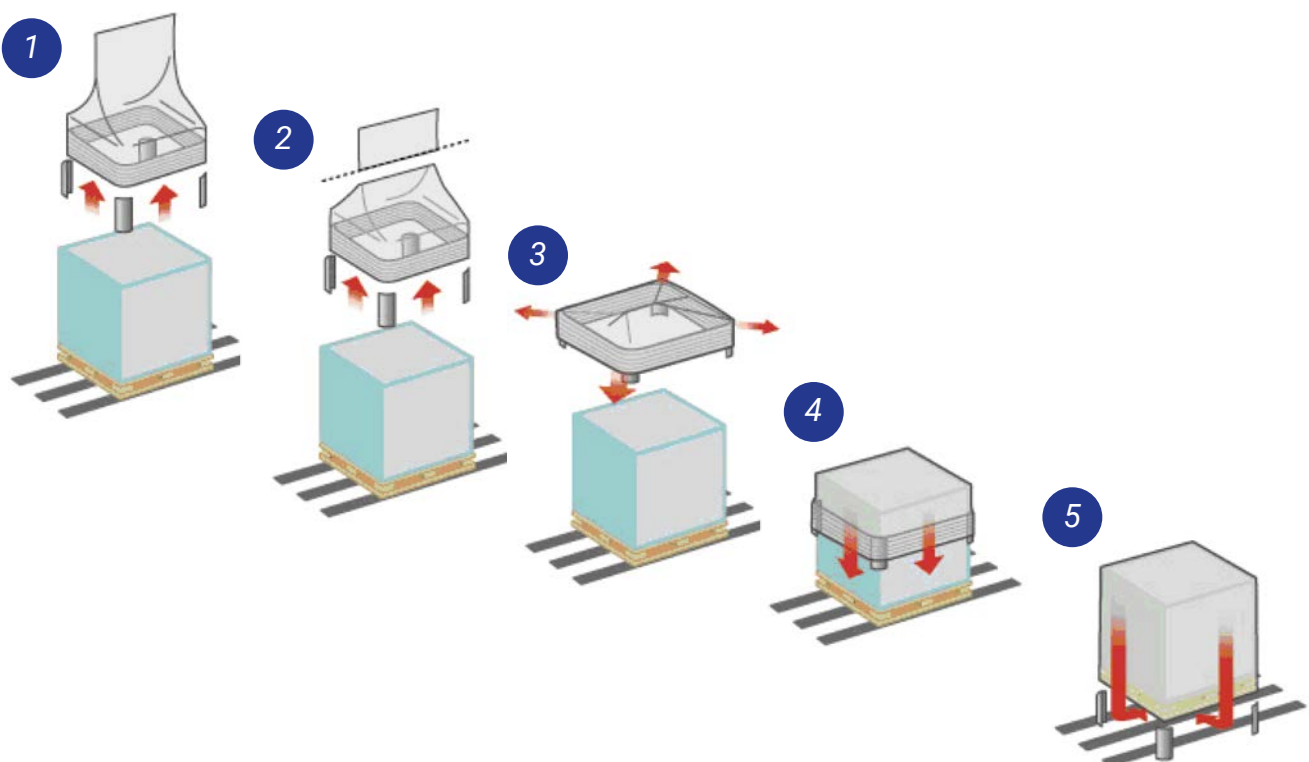

Industrial Polyethylene Bags

Çağ Plastik bags are manufactured in a variety of types, thicknesses, dimensions, colors and at various degrees of UV resistance. The bags are tailored to the type of application and customer requirements. Depending on customer specifications, the bag dimensions can vary between 20 cm width to 5 meters width, at thicknesses ranging between 15 microns and 500 microns. Besides the variability of dimensions and colors, the bags also vary in mechanical strength and their cold – and shock-resistance.

Applications

- Chemical industry
- Construction industry
- Bags for buried bins (Special cut bags inside the box, etc.)
- Various product packaging
- We have (2+2) or (3+3) front and back side industrial printing options. Thus, we can produce Printed LDPE, MDPE, HDPE Bags.





Multi-Purpose Polyethylene (PE) Films:

Our wide range of multi-purpose polyethylene films includes LDPE , MDPE and HDPE films. It is possible to choose from clear and colored films such as white, grey, black and various other shades. Our multi-purpose films are available in different forms (Rolls Folding Type)

Industrial PE Roll Types

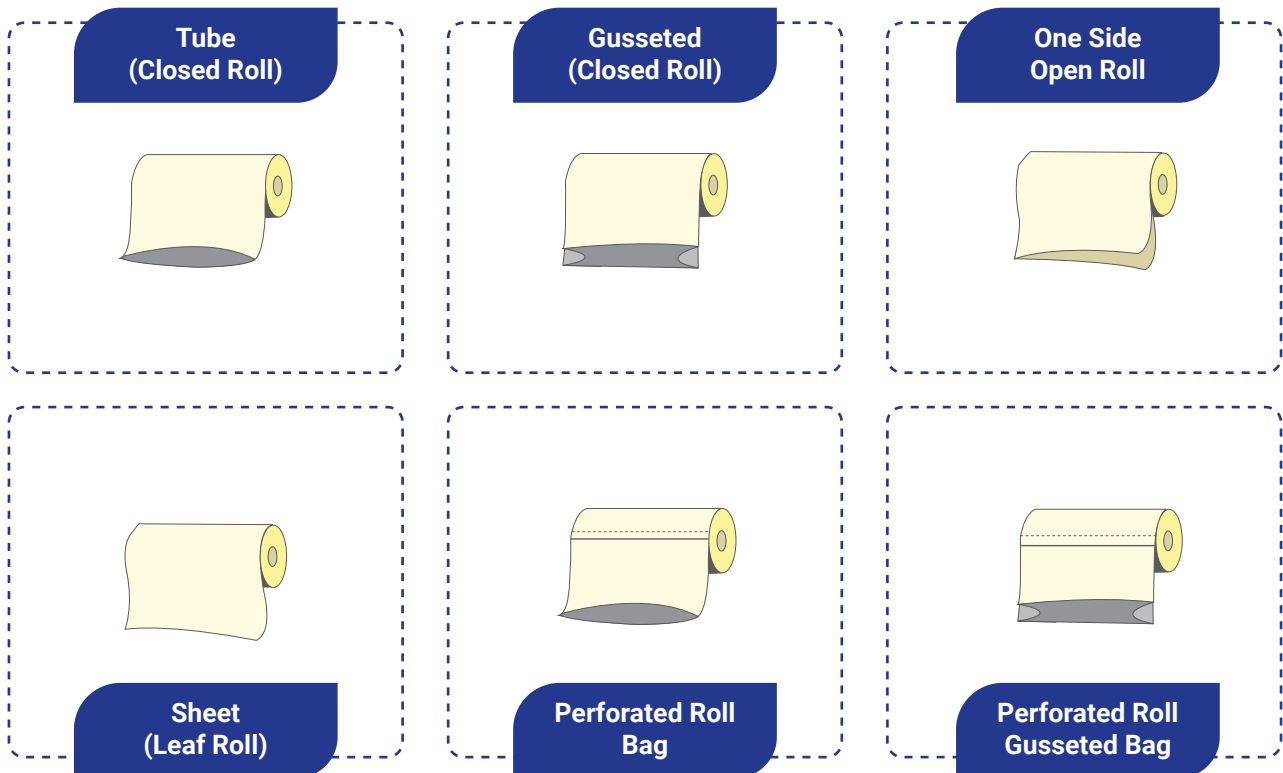

Roll Products

- Sheet (Leaf Roll)
- Tube (Closed Roll)
- Gusseted (Closed Roll)
- One Side Open Roll
- Perforated Roll Flat (Tear-off-perforated)
- Perforated Roll Gusseted (Tear-off-Perforated)
- W-Fold (Double-wound Fold – extra gusseted)

PE (Polyethylene) covers are multipurpose solutions widely used in construction, agriculture and industrial areas. As ÇAĞ Plastik, we offer PE covers in different sizes and thicknesses produced from high quality PE material. These covers stand out with their features such as durability, flexibility, waterproofing and UV resistance. It is also produced using environmentally friendly and recyclable raw materials.

Our PE covers are resistant to harsh weather conditions, chemicals and UV rays. It provides excellent protection against external factors owing to its waterproof structure. It adapts to different areas of use owing to their flexibility.

These covers provide reliable protection in construction sites, agricultural areas, storage and packaging processes. They are also used as under-roof covering and insulation solutions, prevent water leaks and contribute to energy saving.



Agricultural Films

Agricultural Films

Our range of agricultural plastic films are designed to meet every need:



Greenhouses are high system covered structures that are planned to produce or exhibit various culture plants and their seeds, seedlings and saplings throughout the year, regardless of the environmental conditions related to climate, by keeping under control the climate factors such as temperature, humidity, light and ventilation required for the plant, and are made **in different shapes by covering them with light-transmitting materials such as plastic covers etc.**

In terms of construction technique, greenhouses are agricultural structures that are made **by covering a rigid structural frame with a transparent cover material placed at certain intervals** and not changing its shape under the effect of external forces.

As Çağ Plastik Factory; together with our ILERI GREENHOUSE (ILERI SERA) product groups, we serve the sector with our Polyethylene

Greenhouse Cover product range and we produce Polyethylene Greenhouse Cover for covering greenhouses.

With the Polyethylene Greenhouse Film products, we produce; You can cover all Low Tunnel Greenhouse, high tunnel greenhouse, and plastic cover greenhouses. Our product is cheaper and more efficient compared to other greenhouse covering methods such as Glass Greenhouse, Polycarbonate and Sheet Covering etc.

Plant production is generally done in two ways: field farming and covered farming.

Field farming is the cultivation done in large areas depending on the climate conditions of the region. For field open field farming; We produce solutions for our open field farmers with our agricultural product groups. **Some of these are; Silage Film, Mulch film, etc.**

Plant production structures are greenhouse structures created by covering profiles of different cross-sections placed at certain intervals with a transparent cover.

Greenhouse cultivation is defined as low or high systems that are used to perform plant production in a controlled manner by partially or completely eliminating the negative effects of environmental conditions.

Plant production structures used in greenhouse cultivation can be determined in three separate groups

- Low tunnels,
- High tunnels and
- Plastic greenhouses



Growing vegetables, fruits and plants under cover

- Production can be done throughout the year.
- The growing season is extended, increasing the number of cultivated plants.
- A wide variety of products are offered to the market continuously.
- More and higher quality products are obtained from the unit area.
- The use of seasonal labor in agricultural enterprises is made regular and continuous.
- Agricultural migration is prevented.

In terms of productivity, growing vegetables under cover is the most efficient way of agriculture.

Light Transmission

- 85-93% (single layer),
- 76% (double layer),
- IR and UV retention properties can be adjusted,
- Lightweight
- Easy to install,
- High condensation occurs,
- Flexibility
- Lifespan of 3-5 years
- Sizes are different (according to greenhouse dimensions),
- Thickness: 0.15-0.2mm,
- Light transmission decreases from year to year.
- Its prices are much more affordable than other greenhouse methods.

With today's COEX technology, PE cover (PE Films)

- Heat protection and thermal properties are provided with IR additive.
- Life with UV additive and Light Transmittance is managed with Light Stabilators
- Optical properties for viral insects can be given with AV (Anti-Virus) additive.
- Dust adhesion to the outer surface is prevented with AD (Anti-Dust) additive.
- Water droplets are prevented from falling on the plant with AF (Anti-Fog) additive.
- Sunlight is prevented from entering vertically with LD additive and it is distributed evenly inside the greenhouse by refracting the light.
- Features such as light spreading with mineral additives
- Fluorescent properties have been added and widespread use has been achieved

Mulch Films

Mulch Films are produced in thickness 20-30-40-50 microns for a lifetime of minimum 9 Months, 12 Months and 24 Months at most, and they are used to cover the prepared soil. Depends on the thickness, the weight per 1.000 m2 is between 20-50 KG.

The basic benefits of using mulch film are;

- Prevents weed growth
- Prevents the soil becoming dry
- Prevents evaporation in soil
- Keeps the soil heat
- Prevents contamination of crop.

Mulch films are used for different purposes in colours such as black/white, brown/yellow, photo-selective green. Black mulch films are the most preferred due to their high performance in weed control. White is used to keep the soil cool, especially in very hot regions, while specially developed brown and green colours are used in cases where high soil temperature is desired together with weed control. Apart from these, Silver/black Mulch



films are used for special applications, especially in open agricultural areas, such as strawberry production, etc., due to their effects on plant development.



Some of its advantages of Black/Silver Mulch Films are

- Repels flying insects by dazzling their vision,
- It avoids leaves, Fruits and flowers burning,
- Higher uniformity in plants growth,
- Lower mulch film temperature, among others.

PE Silage Cover Films

PE Silage Cover Film is the technique based on the method of storing the forages through fermenting the green and water rich forages in airless environment with the help of lactic acid bacteria, without losing their water and nutritional values. As well as different techniques of silos for silage, also specially produced silage films are used for this purpose.

It is produced Black/White or Black/Green and Black/Black Colours with 12 Months or 24 Months Life-Time UV Additives and between 100-200 micron thicknesses.

We produce 150 micron 12-month with UV additives PE Silage Film, mostly in Black/White or Black/Green, as per our Customers' preference.



Solarization Cover Films

The purpose of using solarization film is to clean the soil from pests. With solarization film, the soil is heated with solar energy and the resulting high heat cleans soil-borne diseases such as nematodes and weeds.

Solarization film is produced in a single layer of 20-30 microns thick transparent film and weighs between 19 kg and 30 kg depending on the film thickness of 1,000 m².

Solarization is done to heat the soil to a depth of at least 40 cm. The following recommendations should be taken into consideration when using solarization film.



Things to Consider When Using Solarization Films

- Solarization should be done in the months when the temperature is highest, and the sunlight is most intense.
- The area where solarization will be applied should be empty, smooth and clean.
- In order to the heat to reach the depths, the soil where solarization will be applied should be saturated with water and should be kept constantly moist.
- The duration of solarization application is between 4-6 weeks.





PE Heat Curtain

Heat Curtain (Wire Top Covering) Film is used inside the greenhouse to reduce heat loss and water droplets condensing on the greenhouse cover from dripping onto the plants. It has a strong and flexible structure thanks to its thin, transparent and high mechanical properties.

Heat Curtain film is generally produced in a single layer of 30 microns and weighs 29-32 kg per 1,000 m².





Greenhouse Films

Greenhouse Covers are widely used to provide suitable conditions for plant growth and to prepare a controllable environment. They can be produced with different features and lifespans depending on the region, plant characteristics and needs.

Advantages of Polyethylene Greenhouse Cover Films

- It is flexible, easily covers the greenhouse frame, and can be shaped.
- Facility costs and application are easier and cheaper.
- According to the installation location or purpose of the greenhouse, covers with many different purposes can be obtained by using variable additives. (UV, AF, IR, PR, AM etc.)
- It is more economical compared to other Greenhouse Cover materials.

İLERİSERA Greenhouse Cover Film Types

İLERİSERA offers its customers various product types according to the usage methods and needs. It is produced and packaged with two different options as Jumbo Roll or Normal Roll.

It is divided into two main basic Greenhouse Cover types as CLEAR and DIFFUSED. CLEAR Greenhouse Covering Films are used in countries and regions with cold climates and long winters where the sun rays are relatively weaker.

DIFFUSED Greenhouse Covering Films are used and preferred in hot or temperate countries where the summer season is long, the winters are relatively mild or not too cold, and the sunlight is intense.

Optional Lifespan Greenhouse Covers Film

They are average performance, general use greenhouse covers produced in accordance with the user's demands, habits and expectations, with a lifespan of 9-12-24-36 and 60 months. They are economical greenhouse films that can contain standard or optional additives according to the user's demand, according to the product feature, and meet the performance that the user expects from the product.

In these products; UV additive is used as standard, but other additives (Please see Greenhouse Covering Film Additives Page) are used optionally according to customer preference.

As Çağ Plastik Factory, some of the special Greenhouse Cover Films product formulas and categories that we have developed and formulated according to our customers and their needs are as shown in the table below.

Product Group	Spec	Mechanical Properties				Optical Properties			
		Tensile Strength (Mpa)		Extension Ratio (%)		Impact Resistance (gr/micron)	IR Effectiveness (%)	Light Transmission 400 - 700 nm (%)	
		MD	TD	MD	TD			Total	Diffused
Standard Films	UV-D	22	23	430	550	3,8	<63	>89	55
	IR-D	22	23	430	550	3,8	>85	>89	55
	UV-C	22	23	430	550	3,8	<63	>89	<28
	IR-C	22	23	430	550	3,8	>85	>89	<32
Professional Films	Diffuse	25	26	520	600	4,4	>87	>89	50-70
	Clear	25	26	520	600	4,4	>87	>89	<28
Premium Films	Diffuse	27	27	520	620	4,8	>88	>89	60
	Clear	27	27	520	620	4,8	>88	>89	<28

As Çağ Plastik Factory; We can offer our ILERISERA Greenhouse Covering Films product groups in 4 x Main Categories

To meet the different needs of our customers and to offer a wide range of products that meet the real needs of farmers by giving optional preferences.

Accordingly, We formulate our products in 4

different categories with **ILERISERA-BASIC**, **ILERISERA-THERMIC**, **ILERISERA-PRO** AND **ILERISERA-PREMIUM** to allow our farmers to choose freely and to respond to their real needs.



Standard Films

12 Months
Greenhouse Films



24 Months
Greenhouse Films



36 Months
Greenhouse Films



48 Months
Greenhouse Films



60 Months
Greenhouse Films



Professional Films



Premium Films

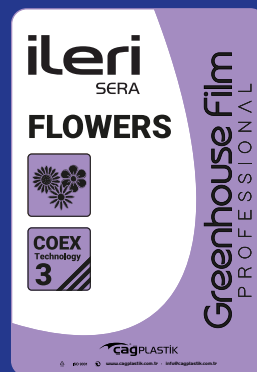

	Details	Product Description	Properties	Explanations
Standard Films	Basic & Thermic Diffused & Clear <i>Both Options Available</i>	12 Months	Contains UV, LD and AD as standard formulation. ⁽¹⁾ Limited chemical resistance.	Greenhouse Films suitable for general use. Thermal properties (IR) can be added as an option.
		24 Months		
		36 Months		
		60 Months		
Professional Films	PRO (Professional) Diffused & Clear <i>Both Options Available</i>	24 Months	Contains UV, IR, AF, LD and AD as standard formulation. ⁽¹⁾ Limited chemical resistance.	Greenhouse Films with high mechanical properties for professional greenhouse applications. They can be produced as transparent upon request. Optionally, moderate ⁽²⁾ or high ⁽³⁾ chemical resistance can be provided.
		36 Months		
		48 Months		
		60 Months		
Premium Films	Premium Diffused & Clear <i>Both Options Available</i>	24 Months	Contains UV, IR, AF, Anti-Mist, LD and AD as standard formulation. ⁽²⁾ Moderate chemical resistance.	Greenhouse Films with high mechanical properties for professional greenhouse applications. Optionally, they can be produced as transparent. Optionally, high ⁽³⁾ chemical resistance can be provided.
		36 Months		
Mulch Films	Black Mulch Film		The soil warms up, retains its heat and moisture, and prevents weed growth.	
	Black/White Mulch Film		Prevents the soil from overheating and maintains its heat and moisture. Prevents weed growth. Provides increased productivity due to the reflection of light in the PAR region.	
	Silver/Black Mulch Film		Prevents the soil from overheating, maintains its heat and moisture. Prevents weed growth. Provides increased productivity due to reflecting light in the PAR region. Reduces pest and red spider density due to reflecting light in the UV region, increases product quality (color, smell, taste).	
Solarization Films	SOL1, SOL-AF		It is used for disinfection and sterilization of soil.	







Chemical Resistance Definitions (for 36 month lifespan films)

- ⁽¹⁾ **Limited Chemical Resistance** : 800 ppm Sulfur - 30 ppm Chlorine
- ⁽²⁾ **Moderate Chemical Resistance** : 1500 ppm Sulfur - 100 ppm Chlorine
- ⁽³⁾ **High Level Chemical Resistance** : 2500 ppm Sulfur - 150 ppm Chlorine

COEX Film Roll Folding Types

Folded Film Width (cm)	Open Film Width (cm)	Roll Winding Widths (cm)						
		Tip 1A	Tip 1B	Tip 2A	Tip 2B	Tip 2C	Tip 2D	Tip 3
		Tube	V Shape	Gusseted Center Cut	Gusseted Center Cut	Gusseted Side Cut	Gusseted Sigma	Sheet
150	300	-	150	-	-	-	80	150
200	400	-	200	-	-	-	105	200
250	500	-	-	-	-	-	130	-
300	600	300	300	155	155	155	155	300
350	700	350	350	180	180	180	-	350
400	800	400	400	205	205	205	-	400
450	900	-	-	230	230	230	-	-
500	1.000	-	-	260	260	260	-	-
600	1.200	-	-	310	310	310	-	-

Folding Types And Specifications

Fold Types	Fold Name	Description	of Layers	View
1A	Tube	Closed Roll	2	
1B	V Shape	Folded One Side Open	2	
2A	Gusseted	Tube	4	
2B	Gusseted	Center Cut	4	
2C	Gusseted	Side Cut	4	
2D	Gusseted	Sigma Fold	4	
3	Sheet	Sheet	1	



Jumbo Rolled Films

According to variable customer needs, ÇAĞ Plastik is capable to produce up to 1 ton jumbo rolled products. In these type of products, 6 " wide cores are used.

These cores are chosen from high-strength plastic, iron or compressed paper. Maximum reel diameter for the rolls are up to 1 meter.

Jumbo rolls can be applied at all greenhouse films , normal ground cover films, solarization films and silage films.



GREENHOUSE FILMS

Additives



Normal

UV (Ultra Violet) / LS (Light Stabilizers)

LS; Light Stabilizers and UV additives both increase the useful lifespan of the film. Depending on the film thickness, desired lifespan of the film and the region that the film will be used, different types and amount of UV Stabilizers are used. These Light Stabilizers determines its type and lifespan of Greenhouse Films.

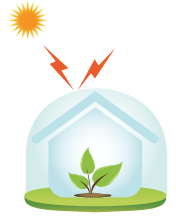

UV

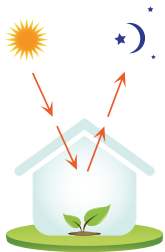

Normal

IR (Infra Red)

During nights and cold days, IR additive decreases heat loss by 2-5 0C by keeping the heat inside greenhouse. IR additive protects the plants from frost, protects from stres and improves plant development. In addition to these, IR provides energy savings in greenhouse heating.



IR



Normal

EVA (Ethylene Vinyl Acetate)

EVA increases the transparency of the film, provides high strength and flexibility.



EVA



Normal

LD (Light Diffuser)

LD additive provides the some portion of sunlight entering inside greenhouse to be diffused and this results in beter plant development and prevents sunburn of the plants.



LD



Normal

AV (Anti Virus)

AV additive prevents insect mobility and some fungi development inside greenhouses.



AV



Normal

AF (Anti Fog)

AF (Anti-Fog) provides the moisture condensed on the film surface forming uniform water layer, and this prevents the water droplets falling on the plants.

*Used Just in Professional Greenhouse Film Series Optionally.



AF



Normal

AD (Anti Dust)

Anti Dust prevents the decrease in light transmission of the film by preventing accumulation of the dust on outer surface of the film.

*Used Just in Professional Greenhouse Film Series Optionally.



AD



Normal

AA (Anti Algae)

Especially and in the areas with high humidity, provides protection to the outer surface of the film against formation of algae.

*Used Just in Professional Greenhouse Film Series Optionally.



AA



AF

AM (Anti Mist)

Prevents mist phenomenon that appears in greenhouses covered by Anti-Fog films as a result of sudden decrease of temperature inside greenhouse

*Used Just in Professional Greenhouse Film Series Optionally.



AM



Normal

PR (Pesticide Resistance)

Provides resistance to greenhouse films against pesticides used in greenhouses.

*Used Just in Professional Greenhouse Film Series Optionally.



PR



Instruction Manual

Greenhouse films that are produced by Çağ Plastik, during their lifetime indicated on the film, has guarantee against UV degradation caused by sunlight in case if it is complied with the handling, storage conditions and terms of use as described below.

Handling and Storage Conditions

- Care should be taken during loading/unloading of the rolls, rolls must not be moved by pulling or dragging on the floor.
- Rolls should be stored in their original packaging in a cool, dry place where no sunlight gets in.
- Rolls should be stored horizontally in a clean place.
- Storage time should not exceed 6 months.
- Products must be checked before unloading, and any non-compliance determined should be reported immediately to Çağ Plastik by photo(s)
- Received materials should be checked if they are the goods ordered and comply with specifications.

Terms Of Use

- All the surface of the construction/frame that the film will be in contact with, must be painted with water-based white paint. Oil-based paint must not be USED. Since it will cause premature degradation, the film must not be laid on rusty/oxidized surfaces.
- Care should be taken that there shouldn't be any sharp, abrasive etc. structure on construction.
- PVC parts on greenhouse construction, in any way, must not be in direct contact with the film.
- The greenhouse construction shouldn't be black or dark colored. There shouldn't be any chemical residues on greenhouse structure.
- If wooden structure is used, the surfaces should be smooth. Care should be taken not to use wooden frame with resin, and wood preservative chemicals, such as tar, petroleum-based preservatives, Sulphur solutions must not be used on wooden frame. The film should not be laid on these kinds of frames.
- Care must be taken not to have any sharp, abrasive, cutting substances in the place where the film will be unrolled.



Installing the Greenhouse Films - (Uncover The Rolls)

Greenhouse films that are produced by Çağ Plastik, during their lifetime indicated on the film, has guarantee against UV degradation caused by sunlight in case if it is complied with the handling, storage conditions and terms of use as described below.

Handling and Storage Conditions

- Film should be installed in the cool hours of the day, preferably in the windless time.
- Film should be properly stretched, leaving the film loose and excessive tension should be avoided.
- In the case of an accidental tear or hole during installation of the film, repair tape prepared specifically for greenhouse films should be used.
- After installation of the film, it should be stretched again after becomes hot.
- The film that will not be used should not be left open and exposed to sun, it should be wrapped again in its own packaging and stored like that.
- Together with the label belong to roll, 1 m² of film; such that. Product information, date, and time written on the film by marking clearly to be read, should be kept as a witness samples.

Film Life (Lifespan of the Greenhouse Films)

- Warranty begins from the date of invoice if the materials are sent directly to end-user.
- Warranty begins one month after the date of invoice, if the materials are sent to dealers/distributors.
- The warranty period begins according to the above-mentioned conditions and ends when the guaranteed lifespan of the film is completed.
- As noted above, the greenhouse cover has protective chemicals against the degradation caused by sunlight.
- According to results of extensive research; some chemicals, used in greenhouses to protect plants, deactivate UV stabilizers used in greenhouse film and this causes premature degradation of the film. Therefore, in greenhouses, use of chemicals that contain Sulphur, bromine, chlorine, fluorine and petroleum-based chemicals should be avoided whenever possible. Care should be taken for the plants and chemicals used not to touch the film. The warranty will not cover the films that have premature degradation caused by such chemicals.

Applications regarding with complaints must be made together with the invoice, the label related with complained film, and film sample

Elevate Greenhouse Films Standards With New Generation Anti-Fog Additives

Long Lasting Performance of AF (Anti-Fog) Additive

24 Months Lifespan Anti-Fog Additive (Anti-Drip) performance We raise the standards with our new generation and longer Anti-Drip additive performance greenhouse films.

- *More light in the greenhouse*
- *Fully active at very low temperatures*
- *Active on smaller roof slopes*
- *Possibility to use the film for many more years*
- *New Performance time with 24 Months Lifetime*
- *More effective anti-drip effect*

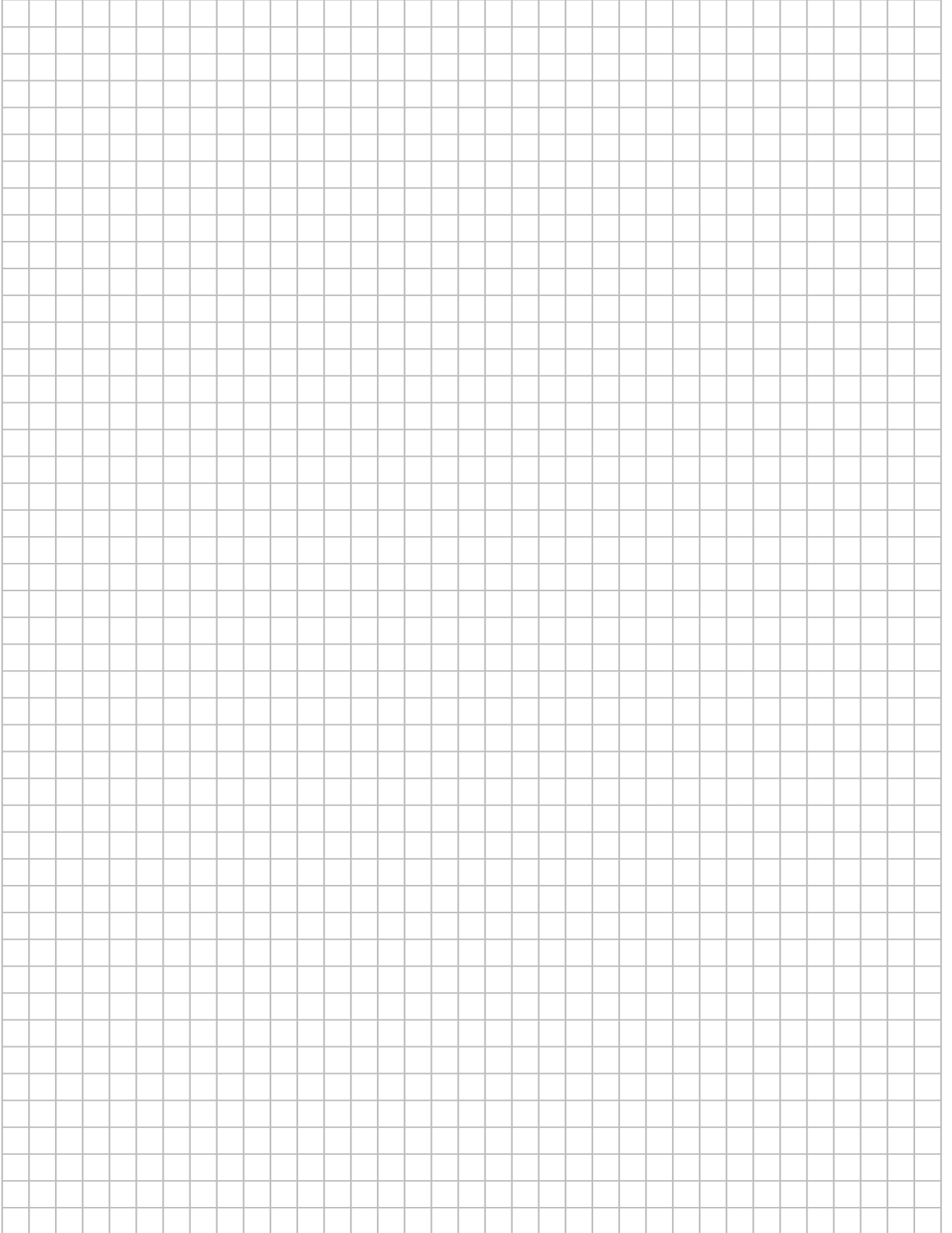

We protect the future with
Eco-Friendly production!

We get the energy required for
production from solar panels.

cağ
PLASTİK

ileri
ÜRÜN GRUBU

www.cagplastik.com.tr

info@cagplastik.com.tr

+90 232 853 97 00